

Isosceles Triangle Theorem

Find the value of x .

1)

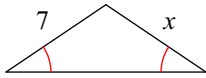

2)

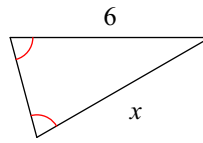

3)

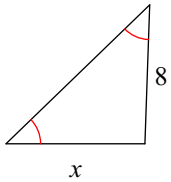

4)

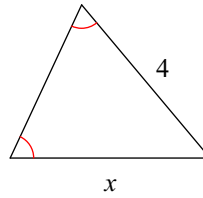

5)

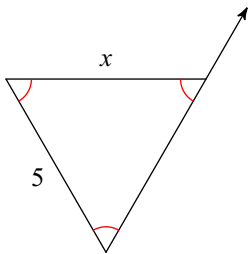

6)

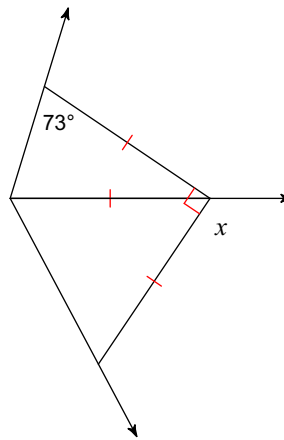

7)

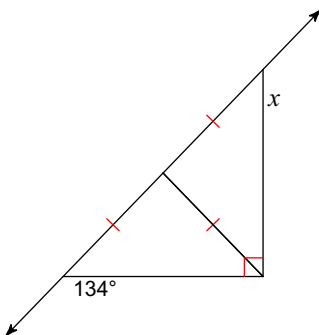

8)

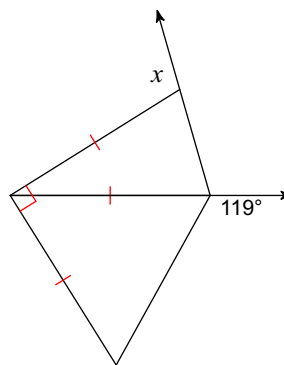

9)

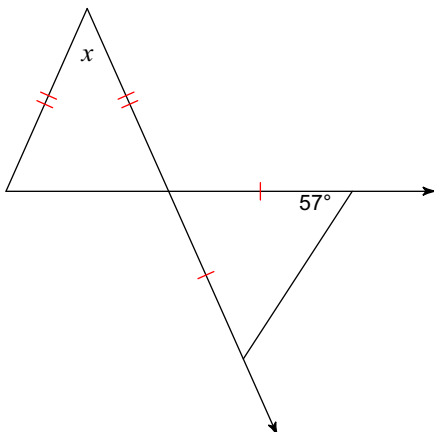

10)

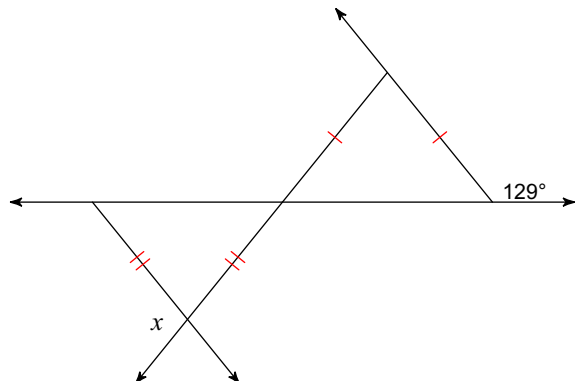

11) $m\angle 2 = 13x + 6$

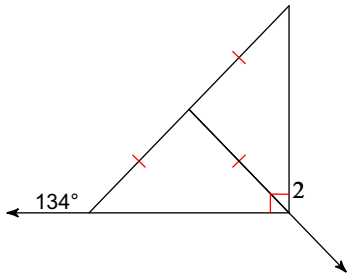

12) $m\angle 2 = x + 153$

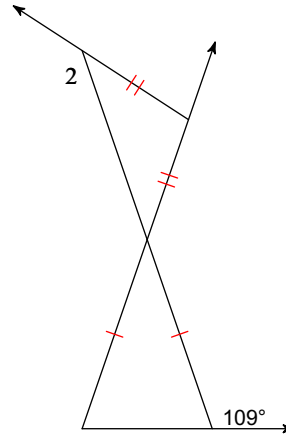

13) $m\angle 2 = x + 92$

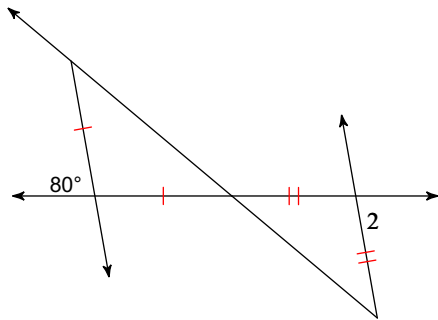

14) $m\angle 2 = 12x - 4$

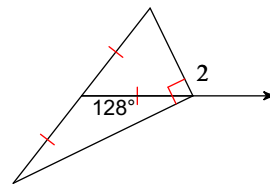

Isosceles Triangle Theorem

Find the value of x .

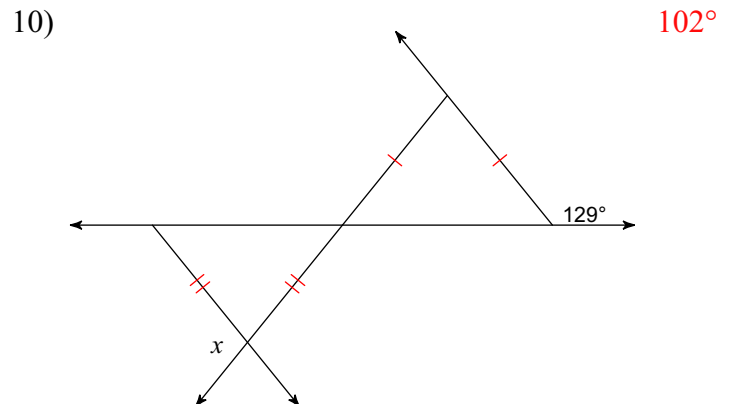
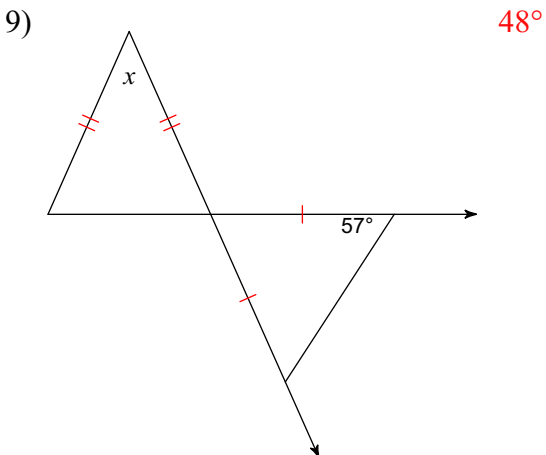
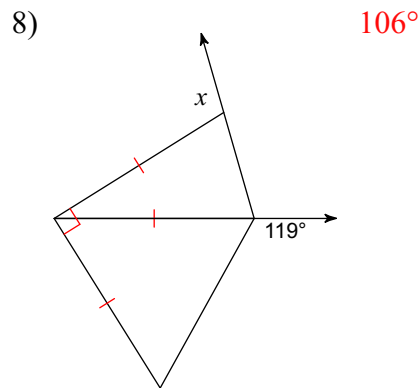
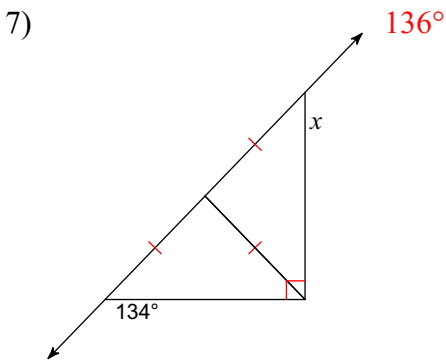
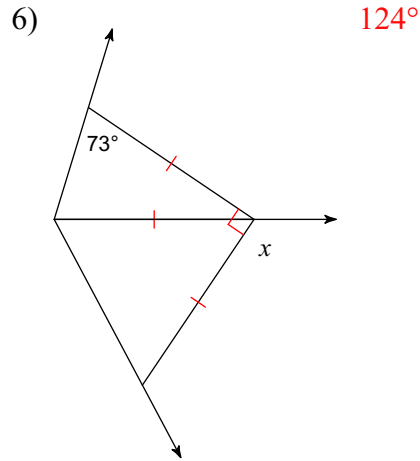
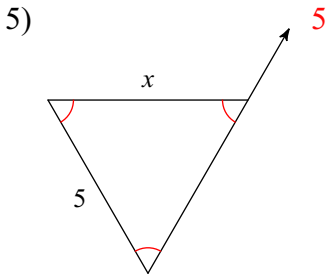
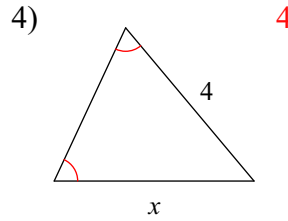
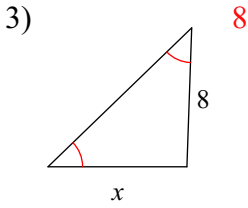
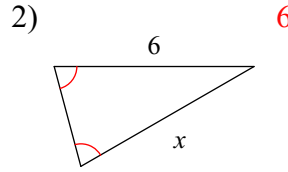
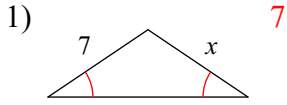

11) $m\angle 2 = 13x + 6$

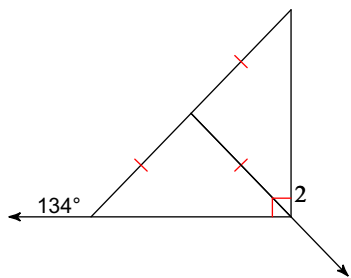

10

12) $m\angle 2 = x + 153$

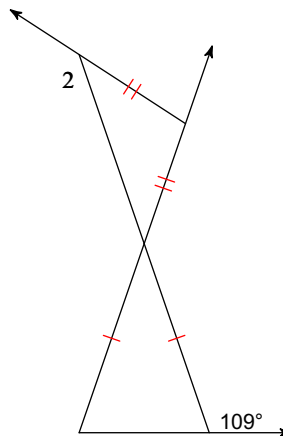

-11

13) $m\angle 2 = x + 92$

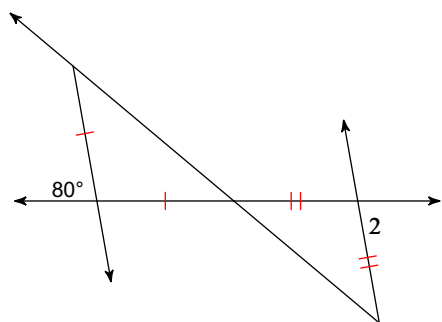

-12

14) $m\angle 2 = 12x - 4$

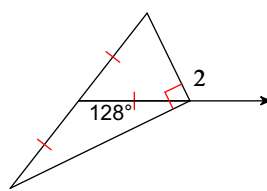

10